

Base Plates • suitable on pallets DIN 55 201

1100.700



Product Description

Material

- Steel, hardened, ground

More information

Notes

Special types on request.

Drawing

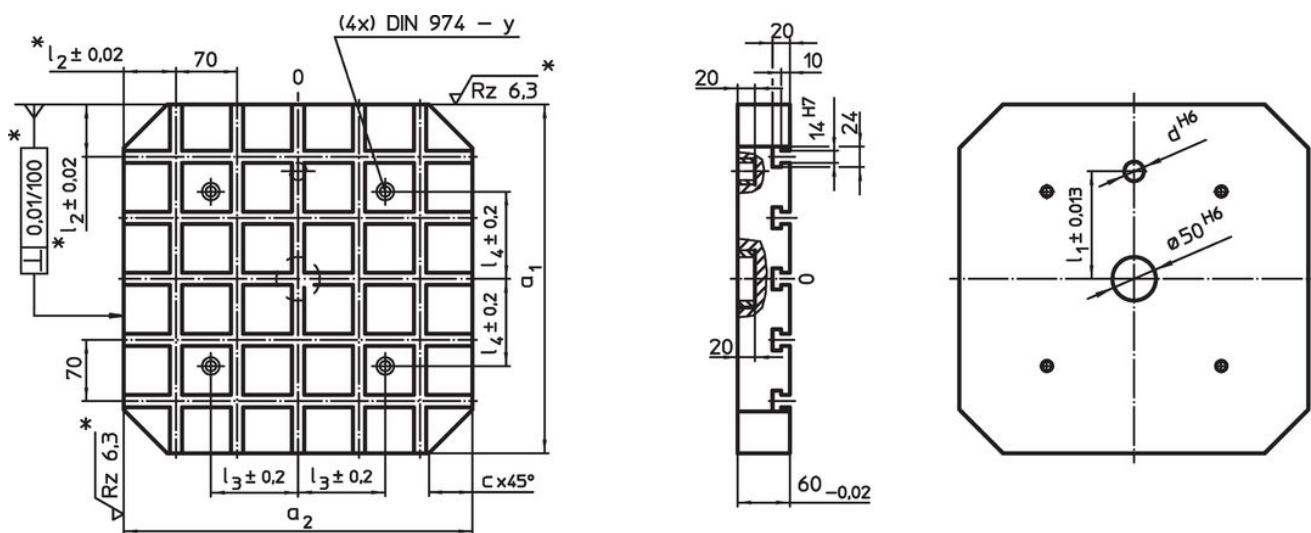

* These tolerances are valid only for optional exterior stop type.
Slot spacing $70 \pm 0,01$.

Order information

System	$a_1 \times a_2$	c	Dimensions				For screws	y	Number of T-slots	[kg]	Art. No.	
			d	$l_1 \pm 0,013$	l_2	l_3						l_4
[mm]												
V70	400 x 400	50	20	150	60	100	100	M12	12	5 x 5	56	1100.700

Application example







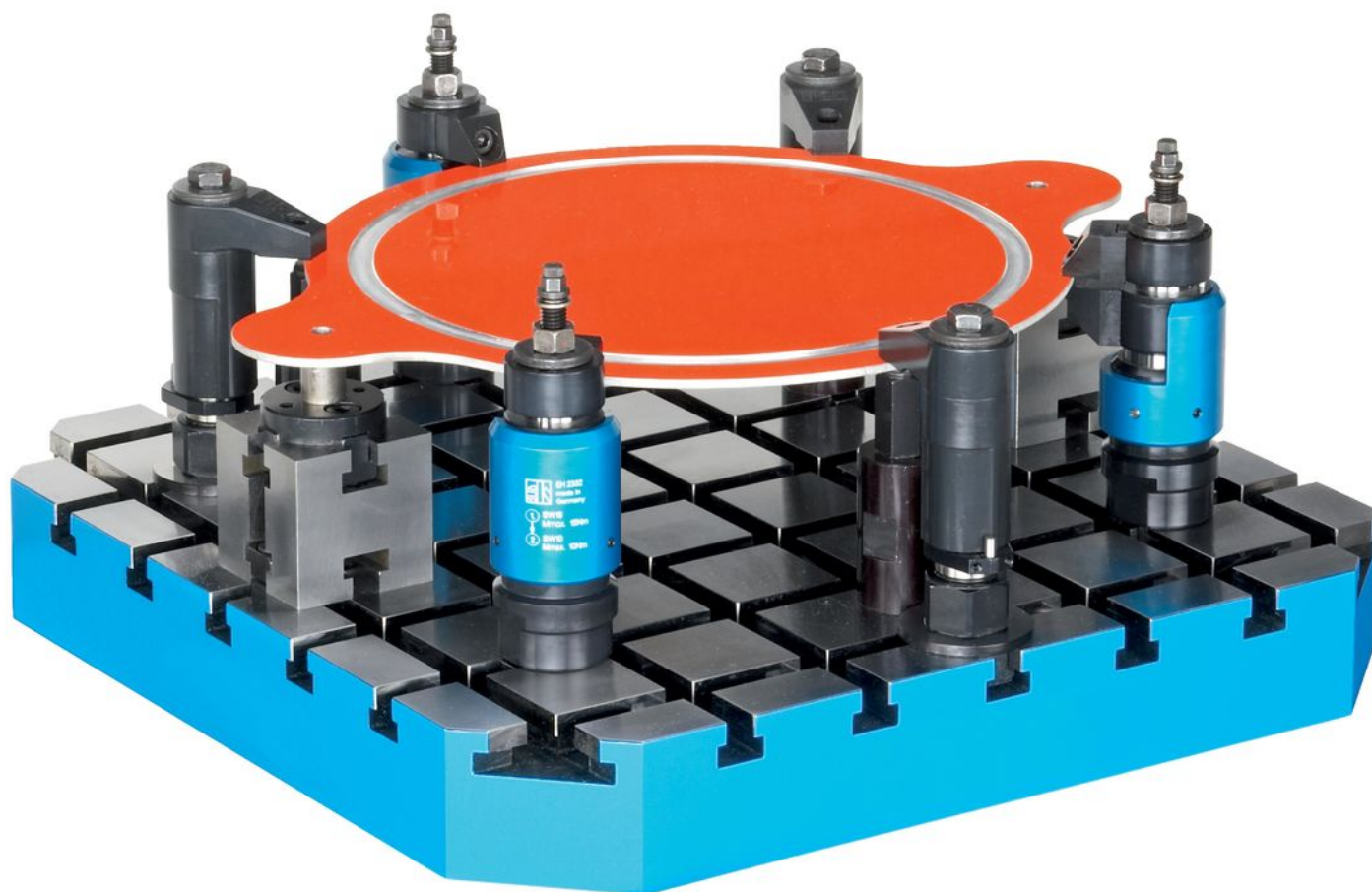

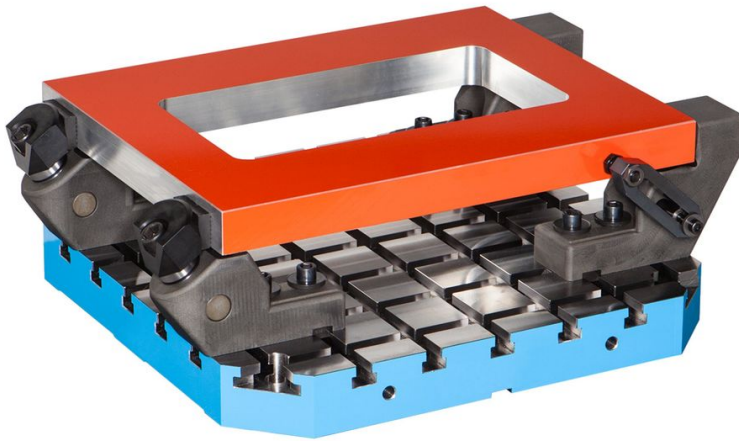

Compliance

RoHS compliant

Compliant according to Directive 2011/65/EU and Directive 2015/863.

Does not contain SVHC substances

No SVHC substances with more than 0.1% w/w contained - SVHC list [REACH] as of 23.01.2024.

Does not contain Proposition 65 substances

No Proposition 65 substances included.

<https://www.P65Warnings.ca.gov/>

Free from Conflict Minerals

This product does not contain any substances designated as "conflict minerals" such as tantalum, tin, gold or tungsten from the Democratic Republic of Congo or adjacent countries.